

MIRA

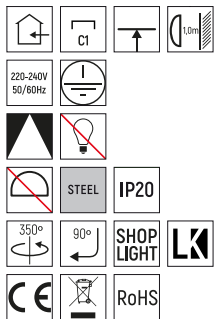

LED
COMPATIBLE

Especificações | Specifications | Spécifications | Especificaciones



Standards

EN 60598-1
EN 60598-2-1

Dimensões | Dimensions | Dimensiones | Dimensiones

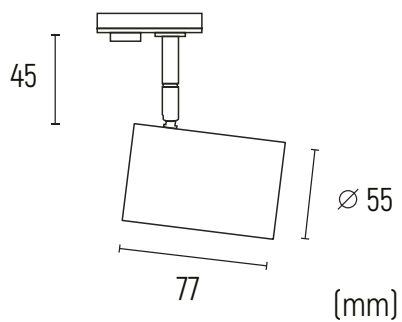

MIRA

W 2770750001 PAR16 GU10 9W
K 2770750002

Outras Informações | Other Informations | Autres renseignements | Otras informaciones



Compatível com | Compatible with | Compatible avec | Compatible con



PAR16 GU10 LED DIM
220-240V 50/60Hz

























PAR16 GU10 LED
220-240V 50/60Hz

Instalação | installation | installation | instalación

| ES | FR | EN | PT | |
|---|--|--|---|---|
| Luminaria para uso en espacios interiores | Luminaire pour une utilisation en espaces intérieurs | Luminaire for indoor use | Luminária para utilização em espaços interiores |  |
| Luminaria para uso en espacios exteriores | Luminaire pour une utilisation en espaces extérieurs | Luminaire for outdoor use | Luminária para utilização em espaços exteriores |  |
| Luminaria para uso en espacios interiores y exteriores | Luminaire pour une utilisation en espaces intérieurs et extérieurs | Luminaire for indoor and outdoor use | Luminária para utilização em espaços interiores e exteriores |  |
| Luminaria recomendada para su aplicación en zonas cercanas al mar o industriales | Luminaire approprié pour une application dans des environnements maritimes ou industriels. | Luminaire suitable for industrial or marine environments | Luminária apropriada para aplicação em ambientes marítimos ou industriais |  |
| Luminaria no recomendada para su aplicación en zonas cercanas al mar o industriales | Luminaire non approprié pour une application dans des environnements maritimes ou industriels. | Luminaire not suitable for industrial or marine environments | Luminária não apropriada para aplicação em ambientes marítimos ou industriais |  |
| Luminaria suministrada con caja de preinstalación | Luminaire fourni avec boîtier de pré-installation | Luminaire supplied with pre-installation box | Luminária fornecida com caixa de pré-instalação |  |
| Luminaria de suelo con aplicación saliente | Luminaire de sol avec une application sortante | Floor luminaire with protruding application | Luminária de pavimento com aplicação saliente |  |
| Luminaria de pared con aplicación saliente | Luminaire mural avec une application sortante | Wall luminaire with protruding application | Luminária de parede com aplicação saliente |  |
| Luminaria de techo con aplicación saliente | Luminaire de plafond avec une application sortante | Ceiling luminaire with protruding application | Luminária de teto com aplicação saliente |  |
| Luminaria de techo con aplicación saliente suspendida | Luminaire de plafond avec une application sortante suspendu | Ceiling luminaire with protruding pendant application | Luminária de teto com aplicação saliente suspensa |  |
| Luminaria de techo con aplicación empotrada suspendida | Luminaire de plafond avec application encastrée suspendu | Ceiling luminaire with recessed pendant application | Luminária de teto com aplicação encastrada suspensa |  |
| Luminaria de techo con aplicación saliente en la pared o en el techo | Luminaire avec une application sortante pour mur ou plafond | Wall or ceiling luminaire with protruding application | Luminária com aplicação saliente em parede ou teto |  |
| Luminaria de pie o de escritorio | Luminaire sur pied ou de bureau | Standing or desk luminaire | Luminária de pé ou secretária |  |
| Luminaria de techo con aplicación empotrada | Luminaire de plafond avec une application encastrée | Ceiling luminaire with recessed application | Luminária de teto com aplicação encastrada |  |
| Luminaria de pared con aplicación empotrada | Luminaire mural avec une application encastrée | Wall luminaire with recessed application | Luminária de parede com aplicação encastrada |  |
| Luminaria de suelo con aplicación de empotrada | Luminaire de sol avec une application encastrée | Floor luminaire with recessed application | Luminária de pavimento com aplicação encastrada |  |
| Luminaria de pared o techo con aplicación empotrada | Luminaire mural ou de plafond avec une application encastrée | Wall or ceiling luminaire with recessed application | Luminária de parede ou teto com aplicação encastrada |  |
| Tamaño y forma del corte para empotrar la luminaria (mm) | Dimension et format de la coupure pour encastrement (mm) | Measurements and shape of cut for recessed luminaire (mm) | Dimensão e formato do corte para encastramento (mm) |  |
| Tamaño y forma del corte para empotrar la luminaria (mm) | Dimension et format de la coupure pour encastrement (mm) | Measurements and shape of cut for recessed luminaire (mm) | Dimensão e formato do corte para encastramento (mm) |  |
| Distancia mínima de seguridad en relación con los objetos iluminados | Distance minimale de sécurité relativement aux objets lumineux | Minimum safety distance from lit-up objects | Distância mínima de segurança relativamente aos objetos iluminados |  |
| Luminaria no apta para cubrir con material aislante térmico | Luminaire non adapté pour être recouvert avec du matériel isolant thermique. | Luminaire not suitable for covering with thermal insulation material | Luminária não apta para ser coberta com material isolante térmico |  |
| Sistema carril 1 circuito | Système de rail 1 circuit | Single-circuit track system | Sistema carril 1 circuito |  |
| Sistema carril 3 circuitos | Système de rail 3 circuits | 3-Circuit track system | Sistema carril 3 circuitos |  |
| Cinta LED y perfiles de aluminio | Ruban LED et profils en aluminium | LED strip and aluminium profiles | Fita LED e perfis de alumínio |  |

Especificações Eléctricas | Electrical Specifications | Spécifications électriques | Especificaciones eléctricas

| PT | EN | FR | ES |
|--|---|--|---|
|  Tensão de alimentação e frequência | Supply voltage and frequency | Tension d'alimentation et de fréquence | Tensión de alimentación y frecuencia |
|  Tensão de alimentação e frequência | Supply voltage and frequency | Tension d'alimentation et de fréquence | Tensión de alimentación y frecuencia |
|  Tensão de alimentação e frequência | Supply voltage and frequency | Tension d'alimentation et de fréquence | Tensión de alimentación y frecuencia |
|  Corrente | Current | Courant | Corriente |
|  Tensão de alimentação | Supply voltage | Tension d'alimentation | Tensión de alimentación |
|  Tensão de alimentação | Supply voltage | Tension d'alimentation | Tensión de alimentación |
|  Kit de emergência | Emergency kit | Kit d'urgence | Kit de emergencia |
|  Equipamento elétrico incluído | Electrical equipment included | Équipement électrique inclus | Equipo eléctrico incluído |
|  Equipamento elétrico não incluído | Electrical equipment not included | Équipement électrique non inclus | Equipo eléctrico no incluído |
|  Luminária com ligador terra - classe I | Luminaire with earthing connection class I | Luminaire avec connecteur de masse classe I | Luminaria con conexión a tierra clase I |
|  Luminária com duplo isolamento - classe II | Luminaire with double insulation - class II | Luminaire avec isolation double - classe II | Luminaria con doble aislamiento- classe II |
|  Luminária CELV - classe III | CELV luminaire - class III | Luminaire CELV - classe III | Luminaria CELV - classe III |
|  Equipado com driver Philips | Philips driver included | Équipé avec le contrôleur Philips | Equipado con controlador Philips |
|  Equipado com driver Vossloh-Schwabe | Vossloh-Schwabe driver included | Équipé avec le contrôleur Vossloh-Schwabe | Equipado con controlador Vossloh-Schwabe |
|  Equipado com driver Mean Well | Mean Well driver included | Équipé avec le contrôleur Mean Well | Equipado con controlador Mean Well |
|  Conetividade sem fios via rádiofrequência | Radio frequency wireless connectivity | Connexion sans fil via radiofréquence | Conectividad inalámbrica via rádiofrequência |
|  Botão regulador intensidade fluxo luminoso | Brightness selection button | Bouton régulateur d'intensité du flux lumineux | Botón regulador de intensidad de flujo luminoso |
|  Botão seletor branco quente - branco frio | Warm white/cool white selection button | Bouton sélecteur blanc chaud blanc froid | Botón de selección blanco cálido blanco frío |
|  Botão seletor de cor RGB | RGB colour selection button | Bouton sélecteur de couleur RGB | Botón de selección de color RGB |
|  Botão seletor de cor RGB + branco | RGB colour + white selection button | Bouton sélecteur de couleur RGB + blanc | Botón de selección de color RGB + blanco |

| | | | |
|--|---|---|---|
|  Classe I - equipamento no qual a protecção contra choque eléctrico não depende apenas do isolamento principal, todas as partes activas perigosas acessíveis estão ligadas a um circuito terra de protecção. | Class I - equipment where the protection against electrical shock does not depend only on the main insulation, and where all the accessible dangerous active parts are connected on a protective earth circuit. | Classe I - Appareils conformes aux exigences de mise à terre des appareils électriques : isolation fonctionnelle de tous les composants et liaison à la terre. | Clase I - equipo en el cual la protección contra descargas eléctricas no depende apenas del aislamiento principal, todas las partes activas de riesgo que se encuentran accesibles, están conectadas. |
|  Classe II - equipamento no qual a protecção contra choque eléctrico não depende apenas do isolamento principal, inclui isolamento duplo ou reforçado. | Class II - equipment where the protection against electrical shock does not depend only on the main insulation, including the double or reinforced. | Classe II - Appareils conformes aux exigences de double isolation des parties actives isolation de tous les composants sans liaison à la terre. avec le circuit électrique. | Clase II - equipo en el cual la protección contra descargas eléctricas no depende apenas del aislamiento principal, incluye doble aislamiento o reforzado. |
|  Classe III - equipamento no qual a protecção contra choque eléctrico depende da alimentação a partir de uma tensão baixa de segurança. | Class III - equipment where the protection against electrical shock depends on the supply from a security low voltage. | Classe III - Appareils conformes aux exigences de la classe III : la protection contre les chocs électriques est garantie par un circuit à très basse tension de sécurité (SELV) ne produisant aucune tension supérieure à 50V. | Clase III - equipo en el cual la protección contra descargas eléctricas depende de la alimentación a partir de una tensión baja de seguridad. |

Dados fotométricos e luminosos | Photometric and luminous Data | Données photométriques et lumineuses | Dados fotométricos y luminosos

| ES | FR | EN | PT | |
|---|---|---|---|---|
| Emisión simétrica de la luz | Émission symétrique de la lumière | Symmetrical light output | Emissão simétrica da luz |  |
| Emisión simétrica de la luz | Émission symétrique de la lumière | Symmetrical light output | Emissão simétrica da luz |  |
| Emisión simétrica de la luz | Émission symétrique de la lumière | Symmetrical light output | Emissão simétrica da luz |  |
| Doble emisión de luz | Émission double de la lumière | Double light output | Dupla emissão de luz |  |
| Doble emisión de luz | Émission double de la lumière | Double light output | Dupla emissão de luz |  |
| Emisión asimétrica de la luz | Émission asymétrique de la lumière | Asymmetrical light output | Emissão assimétrica da luz |  |
| Emisión asimétrica de la luz | Émission asymétrique de la lumière | Asymmetrical light output | Emissão assimétrica da luz |  |
| Emisión de la luz en 360° | Émission de la lumière à 360° | 360° light output | Emissão da luz em 360° |  |
| Doble emisión de luz (haz estrecho + haz ancho) | Émission double de la lumière (faisceau étroit + faisceau large) | Double light output (narrow beam + wide beam) | Dupla emissão de luz (feixe estreito + feixe largo) |  |
| Doble emisión de luz (haz estrecho + haz estrecho) | Émission double de la lumière (faisceau étroit + faisceau étroit) | Double light output (narrow beam + narrow beam) | Dupla emissão de luz (feixe estreito + feixe estreito) |  |
| Doble emisión de luz (haz ancho + haz ancho) | Émission double de la lumière (faisceau large + faisceau large) | Double light output (wide beam + wide beam) | Dupla emissão de luz (feixe largo + feixe largo) |  |
| Ángulo cut-off | Angle cut-off | Cut-off angle | Ângulo cut-off |  |
| Índice de deslumbramiento producido por la luminaria (ver pág. 201) | Indice d'obscurissement produit par le luminaire (voir page 201) | Glare rating produced by the luminaire (see page 201) | Índice de ofuscamento produzido pela luminária (ver pág. 201) |  |
| No incluye bombilla | Lampe non incluse | Light bulb not included | Não inclui lâmpada |  |
| Incluye bombilla | Lampe incluse | Light bulb included | Inclui lâmpada |  |
| Clase de energía | Classe énergétique | Energy class | Classe energética |  |
| Permite la regulación del flujo luminoso | Permet la régulation du flux lumineux | Dimmable | Permite regulação de fluxo luminoso |  |
| Regulación de flujo por corte de fase | Régulation du flux par découpage de phase | Phase-cut dimming | Regulação de fluxo por corte fase |  |
| Regulación de flujo mediante el sistema DALI | Régulation du flux par système DALI | DALI system dimming | Regulação de fluxo por sistema DALI |  |
| Regulación de flujo por botón de presión | Régulation du flux par bouton poussoir | Push button dimming | Regulação de fluxo por botão de pressão |  |
| Regulación de flujo 0-10V | Régulation du flux 0-10V | 0-10V dimming | Regulação de fluxo 0-10V |  |
| Índice de reproducción del color superior >80 (ver pág. 199) | Indice de restitution de couleur supérieur >80 (voir page 199) | Colour rendering index above >80 (see page 199) | Índice de restituição de cor superior >80 (ver pág. 199) |  |
| Índice de reproducción del color superior >80 (ver pág. 199) | Indice de restitution de couleur supérieur >80 (voir page 199) | Colour rendering index above >80 (see page 199) | Índice de restituição de cor superior >80 (ver pág. 199) |  |
| Índice de reproducción del color superior >94 (ver pág. 199) | Indice de restitution de couleur supérieur >94 (voir page 199) | Colour rendering index above >94 (see page 199) | Índice de restituição de cor superior >94 (ver pág. 199) |  |
| Índice de reproducción del color superior >93 (ver pág. 199) | Indice de restitution de couleur supérieur >93 (voir page 199) | Colour rendering index above >93 (see page 199) | Índice de restituição de cor superior >93 (ver pág. 199) |  |
| Índice de reproducción del color superior >93 (ver pág. 199) | Indice de restitution de couleur supérieur >93 (voir page 199) | Colour rendering index above >93 (see page 199) | Índice de restituição de cor superior >93 (ver pág. 199) |  |
| Blanco cálido (Temp° de color en grados Kelvin) | Blanc chaud (Température couleur en degrés Kelvin) | Warm white (colour temperature in kelvin) | Branco quente (Temp° cor em graus Kelvin) |  |
| Blanco neutro (Temp° de color en grados Kelvin) | Blanc neutre (Température couleur en degrés Kelvin) | Neutral white (colour temperature in kelvin) | Branco neutro (Temp° cor em graus Kelvin) |  |

Dados fotométricos e luminosos | Photometric and luminous Data | Données photométriques et lumineuses | Datos fotométricos y luminosos

| | PT | EN | FR | ES |
|--|---|--|--|--|
|  | Branco frio (Temp° cor em graus Kelvin) | Cool white (colour temperature in kelvin) | Blanc froid (Température couleur en degrés Kelvin) | Blanco frío (Temp° de color en grados Kelvin) |
|  | Equipado com LED branco neutro | Equipped with neutral white LED | Équipé avec LED blanche neutre | Equipado con LED blanco neutro |
|  | Equipado com LED branco quente | Equipped with warm white LED | Équipé avec LED blanche chaude | Equipado con LED blanco cálido |
|  | Equipado com LED azul | Equipped with blue LED | Équipé avec LED bleue | Equipado con LED azul |
|  | Equipado com LED verde | Equipped with green LED | Équipé avec LED verte | Equipado con LED verde |
|  | Equipado com LED vermelho | Equipped with red LED | Équipé avec LED rouge | Equipado con LED rojo |
|  | Equipado com LED amarelo | Equipped with yellow LED | Équipé avec LED jaune | Equipado con LED amarillo |
|  | Fotometria disponível | Photometric data available | Photométrie disponible | Fotometría disponible |
|  | Permite regulação de fluxo luminoso | Dimmable | Permet la régulation du flux lumineux | Permite la regulación del flujo luminoso |
|  | Variável entre 2700K e 6500K | Variable between 2700K and 6500K | Variable entre 2700K et 6500K | Variable entre 2700K y 6500K |
|  | Variação de cor apenas em RGB | Colour variation in RGB only | Variation de couleur seulement en RGB | Variación de color solo en RGB |
|  | Variação de cor RGB e 6500K | RGB and 6500K colour variation | Variation de couleur RGB et 6500K | Variación de color RGB y 6500K |
|  | Equipado com LED | Equipped with LED | Équipé avec LED | Equipado con LED |
|  | Equipado com módulo LED substituível | Equipped with replaceable LED module | Équipé avec module LED remplaçable | Equipado con módulo LED reemplazable |
|  | Compatível com diferentes tipos de lâmpada LED | Compatible with different types of LED lamps | Compatible avec différents types de lampe LED | Compatible con diferentes tipos de lámpara LED |
|  | Equipado com LED SMD 2835 | Equipped with SMD 2835 LED | Équipé avec LED SMD 2835 | Equipado con LED SMD 2835 |
|  | Equipado com LED SMD 3528 | Equipped with SMD 3528 LED | Équipé avec LED SMD 3528 | Equipado con LED SMD 3528 |
|  | Equipado com LED SMD 5050 | Equipped with SMD 5050 LED | Équipé avec LED SMD 5050 | Equipado con LED SMD 5050 |
|  | Equipado com LED Cree | Equipped with Cree LED | Équipé avec LED Cree | Equipado con LED Cree |
|  | Equipado com LED Cree (CXA2520) | Equipped with Cree LED (CXA2520) | Équipé avec LED Cree (CXA2520) | Equipado con LED Cree (CXA2520) |
|  | Equipado com LED Cree (CXA2520) | Equipped with Cree LED (CXA2520) | Équipé avec LED Cree (CXA2520) | Equipado con LED Cree (CXA2520) |
|  | Equipado com LED SHARP | Equipped with Sharp LED | Équipé avec LED SHARP | Equipado con LED SHARP |
|  | Equipado com LED Philips | Equipped with Philips LED | Équipé avec LED Philips | Equipado con LED Philips |
|  | Equipado com LED Edison | Equipped with Edison LED | Équipé avec LED Edison | Equipado con LED Edison |
|  | Equipado com LED Cree (CXA1512) | Equipped with Cree LED (CXA1512) | Équipé avec LED Cree (CXA1512) | Equipado con LED Cree (CXA1512) |
|  | Ângulo abertura (° graus) | lens opening angle (in degrees) | Angle d'ouverture (° degrés) | Ángulo de apertura (° grados) |
|  | Suporte G53 | Lampholder G53 | Support G53 | Soporte G53 |
|  | Suporte E27 | Lampholder E27 | Support E27 | Soporte E27 |

Dados fotométricos e luminosos | Photometric and luminous Data | Données photométriques et lumineuses | Datos fotométricos y luminosos

| ES | FR | EN | PT | |
|--|---|-----------------------------------|---|------------|
| SopORTE GU10 | Support GU10 | Lampholder GU10 | Suporte GU10 | GU10 |
| SopORTE GU5.3 | Support GU5.3 | Lampholder GU5.3 | Suporte GU5.3 | GU5.3 |
| Conexión por cable | Connexion par câble | Cable connection | Ligação por cabo | Cable |
| Funcionamiento con lámparas LED MR16 | Fonctionnement avec lampes LED MR16 | Works with MR16 LED lamps | Funcionamento com lâmpadas LED MR16 | MR16 LED |
| Funcionamiento con lámparas LED PAR16 | Fonctionnement avec lampes LED PAR16 | Works with PAR16 LED lamps | Funcionamento com lâmpadas LED PAR16 | PAR16 LED |
| Funcionamiento con lámparas LED AR111 | Fonctionnement avec lampes LED AR111 | Works with AR111 LED lamps | Funcionamento com lâmpadas LED AR111 | 111 LED |
| Funcionamiento con lámparas LED Estándar A60 | Fonctionnement avec lampes LED Standard A60 | Works with standard A60 LED lamps | Standard A60 LED | A60 LED |
| Funcionamiento con módulos LED | Fonctionnement avec modules LED | Works with LED modules | Funcionamento com módulos LED | ENGINE LED |
| Flujo luminoso (lm) | Flux lumineux (lm) | Luminous Flux (lm) | Fluxo luminoso (lm) | 80Lm |

Elementos Construtivos | Constructive Elements | Éléments constructifs | Elementos constructivos

| | PT | EN | FR | ES |
|--|---|------------------------------|------------------------------------|----------------------------------|
|  | Difusor em vidro transparente | Transparent glass diffuser | Diffuseur en verre transparent | Difusor de vidrio transparente |
|  | Difusor em vidro opalino | Opal glass diffuser | Diffuseur en verre opalin | Difusor de vidrio opalino |
|  | Difusor em vidro fosco | Frosted glass diffuser | Diffuseur en verre mat | Difusor de vidrio esmerilado |
|  | Difusor em vidro prismático | Prismatic glass diffuser | Diffuseur en verre prismatique | Difusor de vidrio prismático |
|  | Difusor em acrílico transparente | Transparent acrylic diffuser | Diffuseur en acrylique transparent | Difusor de acrílico transparente |
|  | Difusor em acrílico opalino | Opal acrylic diffuser | Diffuseur en acrylique opalin | Difusor de acrílico opalino |
|  | Difusor em acrílico fosco | Frosted acrylic diffuser | Diffuseur en acrylique mat | Difusor de acrílico mate |
|  | Difusor em acrílico prismático | Prismatic acrylic diffuser | Diffuseur en acrylique prismatique | Difusor de acrílico prismático |
|  | Luminária sem difusor | Luminaire without diffuser | Luminaire sans diffuseur | Luminaria sin difusor |
|  | ABS auto-extinguível | Self-extinguishing ABS | ABS auto extinguable | ABS auto extinguable |
|  | Polycarbonato | Polycarbonate | Polycarbonate | Polycarbonato |
|  | Alumínio extrudido | Extruded aluminium | Aluminium extrudé | Aluminio extruido |
|  | Alumínio injetado | Injected aluminium | Aluminium injecté | Aluminio inyectado |
|  | Aço inoxidável AISI 302 | AISI 302 stainless steel | Acier inoxydable AISI 302 | Acero inoxidable AISI 302 |
|  | Aço inoxidável AISI 304 | AISI 304 stainless steel | Acier inoxydable AISI 304 | Acero inoxidable AISI 304 |
|  | Aço inoxidável AISI 304 | AISI 304 stainless steel | Acier inoxydable AISI 304 | Acero inoxidable AISI 304 |
|  | Aço inoxidável AISI 316 | AISI 316 stainless steel | Acier inoxydable AISI 316 | Acero inoxidable AISI 316 |
|  | Aço inoxidável AISI 316 | AISI 316 stainless steel | Acier inoxydable AISI 316 | Acero inoxidable AISI 316 |
|  | Vidro | Glass | Verre | Vidrio |
|  | Aço | Steel | Acier | Acero |
|  | PMMA transparente | Transparent PMMA | PMMA transparent | PMMA transparente |
|  | PMMA opalino | Opal PMMA | PMMA opalin | PMMA opalino |
|  | PMMA fosco | Frosted PMMA | PMMA mat | PMMA mate |
|  | Acabamento em branco | White finish | Finition en blanc | Acabado en blanco |
|  | Acabamento em preto | Black finish | Finition en noir | Acabado en negro |
|  | Acabamento em cinzento metálico | Metallic grey finish | Finition en gris métallisé | Acabado en gris metálico |
|  | Acabamento em cinzento mate | Matt grey finish | Finition en gris mat | Acabado en gris mate |
|  | Acabamento em cinzento pedra | Stone grey finish | Finition en gris pierre | Acabado en gris piedra |





Elementos Constructivos | Constructive Elements | Éléments constructifs | Elementos constructivos

| ES | FR | EN | PT | |
|---|---|--|--|---|
| Acabado en acero cepillado | Finition en acier brossé | Brushed steel finish | Acabamento em aço escovado |  |
| Acabado en acero inoxidable | Finition en acier inox | Stainless steel finish | Acabamento aço inox |  |
| Acabado en aluminio cepillado | Finition en aluminium brossé | Brushed aluminium finish | Acabamento em alumínio escovado |  |
| Acabado en aluminio pulido | Finition en aluminium poli | Polished aluminium finish | Acabamento em alumínio polido |  |
| Acabado en antracita | Finition en anthracite | Anthracite finish | Acabamento em antracite |  |
| Acabado en cromado | Finition en chromé | Chrome finish | Acabamento em cromado |  |
| Acabado en dorado | Finition en doré | Gold finish | Acabamento em dourado |  |
| Acabado en bronce | Finition en bronze | Bronze finish | Acabamento em bronze |  |
| Acabado en cepillado | Finition en brossé | Brushed finish | Acabamento em escovado |  |
| Azul | Bleu | Blue | Azul |  |
| Verde | Vert | Green | Verde |  |
| Amarillo | Jaune | Yellow | Amarelo |  |
| Rojo | Rouge | Red | Vermelho |  |
| Naranja | Orange | Orange | Laranja |  |
| Violeta | Violet | Violet | Violeta |  |
| Beige | Beige | Beige | Bege |  |
| Índice de protección contra sólidos y líquidos (ver pág. 204) | Indice de protection contre les solides et les liquides (voir page 204) | IP rating against intrusion from solids and liquids (see page 204) | Índice de proteção contra sólidos e líquidos (ver pág. 204) |  |
| Índice de resistencia mecánica al impacto (ver pág. 204) | Indice de résistance mécanique à l'impact (voir page 204) | Mechanical resistance against impact (see page 204) | Índice de resistência mecânica ao impacto (ver pág. 204) |  |

Informação adicional | Additional information | Informations complémentaires | Información adicional

| PT | EN | FR | ES |
|--|--|---|---|
|  Permite rotação horizontal (indicação em graus °) | Possible horizontal rotation (in degrees °) | Permet la rotation horizontale (indication en degrés °) | Permite la rotación horizontal (indicación en grados) |
|  Permite orientação horizontal e vertical (movimento giroscópico) | Possible horizontal and vertical rotation (gyroscopic movement) | Permet l'orientation horizontale et verticale (mouvement gyroscopique) | Permite la orientación horizontal y vertical (movimiento giroscópico) |
|  Permite orientação vertical em apenas 1 sentido (indicação em graus °) | Vertical rotation in only one direction (in degrees °) | Permet l'orientation verticale dans 1 sens seulement (indication en degrés °) | Permite la orientación vertical en 1 sentido (indicación en grados) |
|  Permite orientação vertical em 2 sentidos (indicação em graus °) | Vertical rotation in two directions (in degrees °) | Permet l'orientation verticale dans 2 sens (indication en degrés °) | Permite la orientación vertical en 2 sentidos (indicación en grados) |
|  Luminária adequada para iluminação de espaços comerciais | Luminaire suitable for shop lighting | Luminaire approprié pour l'illumination d'espaces commerciaux | Luminaria adecuada para la iluminación de espacios comerciales |
|  Fornecido com cabo para suspensão (comprimento máx. mts) | Supplied with suspension cable (maximum length in metres) | Fourni avec un câble de suspension (longueur max. mts) | Se suministra con cable de suspensión (longitud máx. metros) |
|  Fornecido com cabo para suspensão (comprimento máx. mts) | Supplied with suspension cable (maximum length in metres) | Fourni avec un câble de suspension (longueur max. mts) | Se suministra con cable de suspensión (longitud máx. metros) |
|  Fornecido com cabo para suspensão (comprimento máx. mts) | Supplied with suspension cable (maximum length in metres) | Fourni avec un câble de suspension (longueur max. mts) | Se suministra con cable de suspensión (longitud máx. metros) |
|  Luminária dotada de dois buçins para efetuar repicagem | Luminaire with two cable glands for rerouting | Luminaire doté de deux presse-étoupes pour effectuer le repiquage | Luminaria dotada de dos prensaestopas para realizar derivación |
|  Admite uma carga máxima (indicação em kg) | Maximum load supported (in kg) | Permet une charge maximale (indication en kg) | Admite una carga máxima (indicación en kg) |
|  Admite uma carga máxima (indicação em kg) | Maximum load supported (in kg) | Permet une charge maximale (indication en kg) | Admite una carga máxima (indicación en kg) |
|  Indicação tempo de vida útil (indicação em horas) | Lifetime (in hours) | Indication du temps de vie utile (indication en heures) | Indicación de tiempo de vida útil (indicación en horas) |
|  Fácil instalação | Easy to install | Installation facile | Fácil instalación |
|  Substituir o difusor em caso de quebra | Replace broken diffuser | Remplacer le diffuseur en cas de cassure | Sustituir el difusor en caso de rotura |
|  Luminária fabricada de acordo com as normas de segurança elétrica e demais legislação aplicável | Luminaire manufactured in accordance with electrical safety standards and other applicable legislation | Luminaire fabriqué en accord avec les normes de sécurité électrique et autre législation applicable | Luminaria de techo fabricada de acuerdo con las normas de seguridad eléctrica y demás legislación aplicable |
|  Luminária totalmente flexível | Fully flexible luminaire | Luminaire totalement flexible | Luminaria totalmente flexible |
|  Elevada resistência ao impacto | High resistance against impact | Résistance élevée à l'impact | Alta resistencia al impacto |
|  Necessita de manutenção e limpeza periódica | Regular cleaning and maintenance required | Nécessite de manutention et de nettoyage périodique | Requiere mantenimiento y limpieza periódica |
|  Necessita fundo de drenagem para escoamento de águas | Floor drainage of liquids required | Nécessite d'un fond de drainage pour écoulement des eaux | Necesita fondo de drenaje para la evacuación de agua |
|  Luminária fornecida com cabo de alimentação (indicação do tipo e metros) | Luminaire supplied with electrical cable (type and length in metres) | Luminaire fourni avec un câble d'alimentation (indication du type et des mètres) | Luminaria suministrada con cable de alimentación (indicación del tipo y metros) |
|  Luminária fornecida com cabo de alimentação e ficha macho | Luminaire supplied with cable and connection plug | Luminaire fourni avec un câble d'alimentation et d'une fiche mâle | Luminaria suministrada con cable de alimentación y enchufe macho |
|  Suporte de lâmpada não incluído na luminária | Lamp holder not included in luminaire | Support de lampe non inclus dans le luminaire | Soporte de bombilla no incluído en la luminaria |
|  Suporte de lâmpada incluído na luminária | Lamp holder included in luminaire | Support de lampe inclus dans le luminaire | Soporte de bombilla incluído en la luminaria |
|  Novo produto | New product | Nouveau produit | Nuevo producto |
|  Cumpre a diretiva REEE | Complies with REEE directive | Respecte la directive REEE | Cumple con la directiva RAEE |
|  Cumpre a diretiva ROHS | Complies with ROHS directive | Respecte la directive ROHS | Cumple con la directiva ROHS |
|  Ostenta certificação TUV GS | TUV GS Certified | Porte la certification TUV GS | Con certificación TUV GS |
|  Ostenta certificação TUV | TUV Certified | Porte la certification TUV | Con certificación TUV |

Informação adicional | Additional information | Informations complémentaires | Información adicional

| ES | FR | EN | PT | |
|--|--|---|---|---|
| Garantía de 4 años en toda la gama Flexistrip | Garantie 4 ans pour toute la gamme Flexistrip | 4-year warranty for entire Flexistrip range | Garantia 4 anos em toda a gama Flexistrip |  |
| Luminaria con garantía Lumitek | Luminaire avec la garantie Lumitek | Luminaire with Lumitek warranty | Luminária com garantia Lumitek |  |
| Calidad comprobada en el producto | Qualité prouvée pour le produit | Proven product quality | Qualidade comprovada no produto |  |
| Diseño patentado | Conception brevetée | Patented design | Design patenteado |  |
| Marca registrada UE | Marque enregistrée UE | EU registered trademark | Marca registada UE |  |
| Estilo vintage | Style Vintage | Vintage style | Estilo vintage |  |
| Sustitución rápida y sencilla del módulo LED | Substitution rapide et simple du module LED | Quick and easy to replace LED | Substituição rápida e simples do módulo LED |  |
| Luminaria con efecto decorativo | Luminaire avec effet décoratif | Luminaire with decorative effect | Luminária com efeito decorativo |  |
| Luminaria con efecto decorativo | Luminaire avec effet décoratif | Luminaire with decorative effect | Luminária com efeito decorativo |  |
| Permite el funcionamiento a temperatura ambiente entre [- ... y + ...] | Permet le fonctionnement pour des températures ambiantes de [- ... et + ...] | Works in ambient temperatures between [- ... and + ...] | Permite o funcionamento em temperaturas ambientes de [- ... e + ...] |  |
| Radio de curvatura mínimo admisible | Rayon de courbure minimal admissible | Minimum radius of curvature admissible | Raio de curvatura mínimo admissível |  |
| Consumo en amperios (A) por metro de cinta | Consommation en ampères (A) par mètre de ruban | Consumption in amperes (A) per metre of strip | Consumo em amperes (A) por metro de fita |  |
| Indicación del espesor de cobre de la cinta (medido en OZ) | Indication de l'épaisseur de cuivre du ruban (mesuré en OZ) | Strip's copper thickness (in OZ) | Indicação da espessura de cobre da fita (medido em OZ) |  |
| Espaciado existente entre LED | Espacement existant entre LEDs | Spacing between LEDs | Espaçamento existente entre LEDs |  |
| Distancia entre cortes y número de LED existentes | Distance entre coupures et nombre de LEDs existantes | Spacing between cuts and number of LEDs | Distância entre cortes e número de LEDs existentes |  |
| Adhesivo térmico de marca 3M | Adhésif thermique de la marque 3M | 3M thermal adhesive tape | Adesivo térmico da marca 3M |  |
| Revestimiento de silicona | Revêtement en silicone | Silicone coating | Revestimento em silicone |  |



Marcação CE:
A ostentação da marcação CE, indica que o equipamento está em conformidade com as directivas europeias para material eléctrico de certos limites de tensão 2006/95/CE e compatibilidade electromagnética 2004/108/CE.

CE Marking:
A CE Marking means that the equipment is in compliance with the European Directives for electrical material of certain voltage limits 2006/95/CE and electromagnetic compatibility 2004/108/CE.

Marca CE:
La marca CE, indica que el equipo está en conformidad con las directivas europeas para material eléctrico dentro de determinados límites de tensión 2006/95/CE y compatibilidad electromagnética 2004/108/CE.

Marquage CE
La présentation du marquage CE indique que le matériel est conforme avec les directives européennes pour les appareils électriques de certaines limites de tension 2006/95/CE et de comptabilité électromagnétique 2004/108/CE.