



# ZEN



UGR<16

Especificações | Specifications | Spécifications | Especificaciones

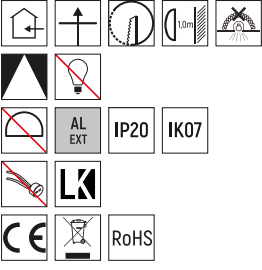

Standards  
EN 60598-1  
EN 60598-2-2

Opcional | Optional | Optionnel | Opcional

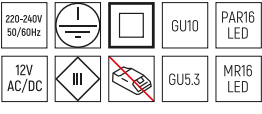

Dimensões | Dimensions | Dimensiones

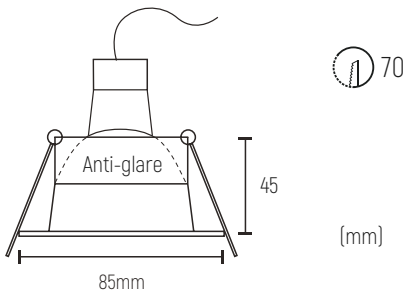

## ZEN

- W** 1710750162 PAR16 GU10 9W / MR16 GU5,3 6W
- PA** 1710750163 PAR16 GU10 9W / MR16 GU5,3 6W

























Outras Informações | Other Informations | Autres renseignements | Otras informaciones























Compatível com | Compatible with | Compatible avec | Compatible con



## Instalação | installation | installation | instalación

ES	FR	EN	PT	
Luminaria para uso en espacios interiores	Luminaire pour une utilisation en espaces intérieurs	Luminaire for indoor use	Luminária para utilização em espaços interiores	
Luminaria para uso en espacios exteriores	Luminaire pour une utilisation en espaces extérieurs	Luminaire for outdoor use	Luminária para utilização em espaços exteriores	
Luminaria para uso en espacios interiores y exteriores	Luminaire pour une utilisation en espaces intérieurs et extérieurs	Luminaire for indoor and outdoor use	Luminária para utilização em espaços interiores e exteriores	
Luminaria recomendada para su aplicación en zonas cercanas al mar o industriales	Luminaire approprié pour une application dans des environnements maritimes ou industriels.	Luminaire suitable for industrial or marine environments	Luminária apropriada para aplicação em ambientes marítimos ou industriais	
Luminaria no recomendada para su aplicación en zonas cercanas al mar o industriales	Luminaire non approprié pour une application dans des environnements maritimes ou industriels.	Luminaire not suitable for industrial or marine environments	Luminária não apropriada para aplicação em ambientes marítimos ou industriais	
Luminaria suministrada con caja de preinstalación	Luminaire fourni avec boîtier de pré-installation	Luminaire supplied with pre-installation box	Luminária fornecida com caixa de pré-instalação	
Luminaria de suelo con aplicación saliente	Luminaire de sol avec une application sortante	Floor luminaire with protruding application	Luminária de pavimento com aplicação saliente	
Luminaria de pared con aplicación saliente	Luminaire mural avec une application sortante	Wall luminaire with protruding application	Luminária de parede com aplicação saliente	
Luminaria de techo con aplicación saliente	Luminaire de plafond avec une application sortante	Ceiling luminaire with protruding application	Luminária de teto com aplicação saliente	
Luminaria de techo con aplicación saliente suspendida	Luminaire de plafond avec une application sortante suspendu	Ceiling luminaire with protruding pendant application	Luminária de teto com aplicação saliente suspensa	
Luminaria de techo con aplicación empotrada suspendida	Luminaire de plafond avec application encastrée suspendu	Ceiling luminaire with recessed pendant application	Luminária de teto com aplicação encastrada suspensa	
Luminaria de techo con aplicación saliente en la pared o en el techo	Luminaire avec une application sortante pour mur ou plafond	Wall or ceiling luminaire with protruding application	Luminária com aplicação saliente em parede ou teto	
Luminaria de pie o de escritorio	Luminaire sur pied ou de bureau	Standing or desk luminaire	Luminária de pé ou secretária	
Luminaria de techo con aplicación empotrada	Luminaire de plafond avec une application encastrée	Ceiling luminaire with recessed application	Luminária de teto com aplicação encastrada	
Luminaria de pared con aplicación empotrada	Luminaire mural avec une application encastrée	Wall luminaire with recessed application	Luminária de parede com aplicação encastrada	
Luminaria de suelo con aplicación de empotrada	Luminaire de sol avec une application encastrée	Floor luminaire with recessed application	Luminária de pavimento com aplicação encastrada	
Luminaria de pared o techo con aplicación empotrada	Luminaire mural ou de plafond avec une application encastrée	Wall or ceiling luminaire with recessed application	Luminária de parede ou teto com aplicação encastrada	
Tamaño y forma del corte para empotrar la luminaria (mm)	Dimension et format de la coupure pour encastrement (mm)	Measurements and shape of cut for recessed luminaire (mm)	Dimensão e formato do corte para encastramento (mm)	
Tamaño y forma del corte para empotrar la luminaria (mm)	Dimension et format de la coupure pour encastrement (mm)	Measurements and shape of cut for recessed luminaire (mm)	Dimensão e formato do corte para encastramento (mm)	
Distancia mínima de seguridad en relación con los objetos iluminados	Distance minimale de sécurité relativement aux objets lumineux	Minimum safety distance from lit-up objects	Distância mínima de segurança relativamente aos objetos iluminados	
Luminaria no apta para cubrir con material aislante térmico	Luminaire non adapté pour être recouvert avec du matériel isolant thermique.	Luminaire not suitable for covering with thermal insulation material	Luminária não apta para ser coberta com material isolante térmico	
Sistema carril 1 circuito	Système de rail 1 circuit	Single-circuit track system	Sistema carril 1 circuito	
Sistema carril 3 circuitos	Système de rail 3 circuits	3-Circuit track system	Sistema carril 3 circuitos	
Cinta LED y perfiles de aluminio	Ruban LED et profils en aluminium	LED strip and aluminium profiles	Fita LED e perfis de alumínio	

# Especificações Eléctricas | Electrical Specifications | Spécifications électriques | Especificaciones eléctricas

	PT	EN	FR	ES
	<b>Tensão de alimentação e frequência</b>	Supply voltage and frequency	Tension d'alimentation et de fréquence	Tensión de alimentación y frecuencia
	<b>Tensão de alimentação e frequência</b>	Supply voltage and frequency	Tension d'alimentation et de fréquence	Tensión de alimentación y frecuencia
	<b>Tensão de alimentação e frequência</b>	Supply voltage and frequency	Tension d'alimentation et de fréquence	Tensión de alimentación y frecuencia
	<b>Corrente</b>	Current	Courant	Corriente
	<b>Tensão de alimentação</b>	Supply voltage	Tension d'alimentation	Tensión de alimentación
	<b>Tensão de alimentação</b>	Supply voltage	Tension d'alimentation	Tensión de alimentación
	<b>Kit de emergência</b>	Emergency kit	Kit d'urgence	Kit de emergencia
	<b>Equipamento elétrico incluído</b>	Electrical equipment included	Équipement électrique inclus	Equipo eléctrico incluído
	<b>Equipamento elétrico não incluído</b>	Electrical equipment not included	Équipement électrique non inclus	Equipo eléctrico no incluído
	<b>Luminária com ligador terra - classe I</b>	Luminaire with earthing connection class I	Luminaire avec connecteur de masse classe I	Luminaria con conexión a tierra clase I
	<b>Luminária com duplo isolamento - classe II</b>	Luminaire with double insulation - class II	Luminaire avec isolation double - classe II	Luminaria con doble aislamiento- clase II
	<b>Luminária CELV - classe III</b>	CELV luminaire - class III	Luminaire CELV - classe III	Luminaria CELV - clase III
	<b>Equipado com driver Philips</b>	Philips driver included	Équipé avec le contrôleur Philips	Equipado con controlador Philips
	<b>Equipado com driver Vossloh-Schwabe</b>	Vossloh-Schwabe driver included	Équipé avec le contrôleur Vossloh-Schwabe	Equipado con controlador Vossloh-Schwabe
	<b>Equipado com driver Mean Well</b>	Mean Well driver included	Équipé avec le contrôleur Mean Well	Equipado con controlador Mean Well
	<b>Conetividade sem fios via rádiofrequência</b>	Radio frequency wireless connectivity	Connexion sans fil via radiofréquence	Conectividad inalámbrica vía rádiofrequência
	<b>Botão regulador intensidade fluxo luminoso</b>	Brightness selection button	Bouton régulateur d'intensité du flux lumineux	Botón regulador de intensidad de flujo luminoso
	<b>Botão seletor branco quente - branco frio</b>	Warm white/cool white selection button	Bouton sélecteur blanc chaud blanc froid	Botón de selección blanco cálido blanco frío
	<b>Botão seletor de cor RGB</b>	RGB colour selection button	Bouton sélecteur de couleur RGB	Botón de selección de color RGB
	<b>Botão seletor de cor RGB + branco</b>	RGB colour + white selection button	Bouton sélecteur de couleur RGB + blanc	Botón de selección de color RGB + blanco



Classe I - equipamento no qual a protecção contra choque eléctrico não depende apenas do isolamento principal, todas as partes activas perigosas acessíveis estão ligadas a um circuito terra de protecção.

Class I - equipment where the protection against electrical shock does not depend only on the main insulation, and where all the accessible dangerous active parts are connected on a protective earth circuit.

Classe I - Appareils conformes aux exigences de mise à terre des appareils électriques : isolation fonctionnelle de tous les composants et liaison à la terre.

Clase I - equipo en el cual la protección contra descargas eléctricas no depende apenas del aislamiento principal, todas las partes activas de riesgo que se encuentran accesibles, están conectadas.



Classe II - equipamento no qual a protecção contra choque eléctrico não depende apenas do isolamento principal, inclui isolamento duplo ou reforçado.

Class II - equipment where the protection against electrical shock does not depend only on the main insulation, including the double or reinforced.

Classe II - Appareils conformes aux exigences de double isolation des parties actives isolation de tous les composants sans liaison à la terre. avec le circuit électrique.

Clase II - equipo en el cual la protección contra descargas eléctricas no depende apenas del aislamiento principal, incluye doble aislamiento o reforzado.



Classe III - equipamento no qual a protecção contra choque eléctrico depende da alimentação a partir de uma tensão baixa de segurança.

Class III - equipment where the protection against electrical shock depends on the supply from a security low voltage.

Classe III - Appareils conformes aux exigences de la classe III : la protection contre les chocs électriques est garantie par un circuit à très basse tension de sécurité (SELV) ne produisant aucune tension supérieure à 50V.

Clase III - equipo en el cual la protección contra descargas eléctricas depende de la alimentación a partir de una tensión baja de seguridad.

Dados fotométricos e luminosos | Photometric and luminous Data | Données photométriques et lumineuses | Dados fotométricos y luminosos

ES	FR	EN	PT	
Emisión simétrica de la luz	Émission symétrique de la lumière	Symmetrical light output	Emissão simétrica da luz	
Emisión simétrica de la luz	Émission symétrique de la lumière	Symmetrical light output	Emissão simétrica da luz	
Emisión simétrica de la luz	Émission symétrique de la lumière	Symmetrical light output	Emissão simétrica da luz	
Doble emisión de luz	Émission double de la lumière	Double light output	Dupla emissão de luz	
Doble emisión de luz	Émission double de la lumière	Double light output	Dupla emissão de luz	
Emisión asimétrica de la luz	Émission asymétrique de la lumière	Asymmetrical light output	Emissão assimétrica da luz	
Emisión asimétrica de la luz	Émission asymétrique de la lumière	Asymmetrical light output	Emissão assimétrica da luz	
Emisión de la luz en 360°	Émission de la lumière à 360°	360° light output	Emissão da luz em 360°	
Doble emisión de luz (haz estrecho + haz ancho)	Émission double de la lumière (faisceau étroit + faisceau large)	Double light output (narrow beam + wide beam)	Dupla emissão de luz (feixe estreito + feixe largo)	
Doble emisión de luz (haz estrecho + haz estrecho)	Émission double de la lumière (faisceau étroit + faisceau étroit)	Double light output (narrow beam + narrow beam)	Dupla emissão de luz (feixe estreito + feixe estreito)	
Doble emisión de luz (haz ancho + haz ancho)	Émission double de la lumière (faisceau large + faisceau large)	Double light output (wide beam + wide beam)	Dupla emissão de luz (feixe largo + feixe largo)	
Ángulo cut-off	Angle cut-off	Cut-off angle	Ângulo cut-off	
Índice de deslumbramiento producido por la luminaria (ver pág. 201)	Indice d'obscurissement produit par le luminaire (voir page 201)	Glare rating produced by the luminaire (see page 201)	Índice de ofuscamento produzido pela luminária (ver pág. 201)	
No incluye bombilla	Lampe non incluse	Light bulb not included	Não inclui lâmpada	
Incluye bombilla	Lampe incluse	Light bulb included	Inclui lâmpada	
Clase de energía	Classe énergétique	Energy class	Classe energética	
Permite la regulación del flujo luminoso	Permet la régulation du flux lumineux	Dimmable	Permite regulação de fluxo luminoso	
Regulación de flujo por corte de fase	Régulation du flux par découpage de phase	Phase-cut dimming	Regulação de fluxo por corte fase	
Regulación de flujo mediante el sistema DALI	Régulation du flux par système DALI	DALI system dimming	Regulação de fluxo por sistema DALI	
Regulación de flujo por botón de presión	Régulation du flux par bouton poussoir	Push button dimming	Regulação de fluxo por botão de pressão	
Regulación de flujo 0-10V	Régulation du flux 0-10V	0-10V dimming	Regulação de fluxo 0-10V	
Índice de reproducción del color superior >80 (ver pág. 199)	Indice de restitution de couleur supérieur >80 (voir page 199)	Colour rendering index above >80 (see page 199)	Índice de restituição de cor superior >80 (ver pág. 199)	
Índice de reproducción del color superior >80 (ver pág. 199)	Indice de restitution de couleur supérieur >80 (voir page 199)	Colour rendering index above >80 (see page 199)	Índice de restituição de cor superior >80 (ver pág. 199)	
Índice de reproducción del color superior >94 (ver pág. 199)	Indice de restitution de couleur supérieur >94 (voir page 199)	Colour rendering index above >94 (see page 199)	Índice de restituição de cor superior >94 (ver pág. 199)	
Índice de reproducción del color superior >93 (ver pág. 199)	Indice de restitution de couleur supérieur >93 (voir page 199)	Colour rendering index above >93 (see page 199)	Índice de restituição de cor superior >93 (ver pág. 199)	
Índice de reproducción del color superior >93 (ver pág. 199)	Indice de restitution de couleur supérieur >93 (voir page 199)	Colour rendering index above >93 (see page 199)	Índice de restituição de cor superior >93 (ver pág. 199)	
Blanco cálido (Temp° de color en grados Kelvin)	Blanc chaud (Température couleur en degrés Kelvin)	Warm white (colour temperature in kelvin)	Branco quente (Temp° cor em graus Kelvin)	
Blanco neutro (Temp° de color en grados Kelvin)	Blanc neutre (Température couleur en degrés Kelvin)	Neutral white (colour temperature in kelvin)	Branco neutro (Temp° cor em graus Kelvin)	

Dados fotométricos e luminosos | Photometric and luminous Data | Données photométriques et lumineuses | Datos fotométricos y luminosos

	PT	EN	FR	ES
	<b>Branco frio (Temp° cor em graus Kelvin)</b>	Cool white (colour temperature in kelvin)	Blanc froid (Température couleur en degrés Kelvin)	Blanco frío (Temp° de color en grados Kelvin)
	<b>Equipado com LED branco neutro</b>	Equipped with neutral white LED	Équipé avec LED blanche neutre	Equipado con LED blanco neutro
	<b>Equipado com LED branco quente</b>	Equipped with warm white LED	Équipé avec LED blanche chaude	Equipado con LED blanco cálido
	<b>Equipado com LED azul</b>	Equipped with blue LED	Équipé avec LED bleue	Equipado con LED azul
	<b>Equipado com LED verde</b>	Equipped with green LED	Équipé avec LED verte	Equipado con LED verde
	<b>Equipado com LED vermelho</b>	Equipped with red LED	Équipé avec LED rouge	Equipado con LED rojo
	<b>Equipado com LED amarelo</b>	Equipped with yellow LED	Équipé avec LED jaune	Equipado con LED amarillo
	<b>Fotometria disponível</b>	Photometric data available	Photométrie disponible	Fotometría disponible
	<b>Permite regulação de fluxo luminoso</b>	Dimmable	Permet la régulation du flux lumineux	Permite la regulación del flujo luminoso
	<b>Variável entre 2700K e 6500K</b>	Variable between 2700K and 6500K	Variable entre 2700K et 6500K	Variable entre 2700K y 6500K
	<b>Variação de cor apenas em RGB</b>	Colour variation in RGB only	Variation de couleur seulement en RGB	Variación de color solo en RGB
	<b>Variação de cor RGB e 6500K</b>	RGB and 6500K colour variation	Variation de couleur RGB et 6500K	Variación de color RGB y 6500K
	<b>Equipado com LED</b>	Equipped with LED	Équipé avec LED	Equipado con LED
	<b>Equipado com módulo LED substituível</b>	Equipped with replaceable LED module	Équipé avec module LED remplaçable	Equipado con módulo LED reemplazable
	<b>Compatível com diferentes tipos de lâmpada LED</b>	Compatible with different types of LED lamps	Compatible avec différents types de lampe LED	Compatible con diferentes tipos de lámpara LED
	<b>Equipado com LED SMD 2835</b>	Equipped with SMD 2835 LED	Équipé avec LED SMD 2835	Equipado con LED SMD 2835
	<b>Equipado com LED SMD 3528</b>	Equipped with SMD 3528 LED	Équipé avec LED SMD 3528	Equipado con LED SMD 3528
	<b>Equipado com LED SMD 5050</b>	Equipped with SMD 5050 LED	Équipé avec LED SMD 5050	Equipado con LED SMD 5050
	<b>Equipado com LED Cree</b>	Equipped with Cree LED	Équipé avec LED Cree	Equipado con LED Cree
	<b>Equipado com LED Cree (CXA2520)</b>	Equipped with Cree LED ( CXA2520 )	Équipé avec LED Cree (CXA2520)	Equipado con LED Cree (CXA2520)
	<b>Equipado com LED Cree (CXA2520)</b>	Equipped with Cree LED ( CXA2520 )	Équipé avec LED Cree (CXA2520)	Equipado con LED Cree (CXA2520)
	<b>Equipado com LED SHARP</b>	Equipped with Sharp LED	Équipé avec LED SHARP	Equipado con LED SHARP
	<b>Equipado com LED Philips</b>	Equipped with Philips LED	Équipé avec LED Philips	Equipado con LED Philips
	<b>Equipado com LED Edison</b>	Equipped with Edison LED	Équipé avec LED Edison	Equipado con LED Edison
	<b>Equipado com LED Cree (CXA1512)</b>	Equipped with Cree LED ( CXA1512)	Équipé avec LED Cree (CXA1512)	Equipado con LED Cree (CXA1512)
	<b>Ângulo abertura (° graus)</b>	lens opening angle (in degrees)	Angle d'ouverture (° degrés)	Ángulo de apertura (° grados)
	<b>Suporte G53</b>	Lampholder G53	Support G53	Soporte G53
	<b>Suporte E27</b>	Lampholder E27	Support E27	Soporte E27

Dados fotométricos e luminosos | Photometric and luminous Data | Données photométriques et lumineuses | Datos fotométricos y luminosos



















ES	FR	EN	PT	
SopORTE GU10	Support GU10	Lampholder GU10	<b>Suporte GU10</b>	GU10
SopORTE GU5.3	Support GU5.3	Lampholder GU5.3	<b>Suporte GU5.3</b>	GU5.3
Conexión por cable	Connexion par câble	Cable connection	<b>Ligação por cabo</b>	Cable
Funcionamiento con lámparas LED MR16	Fonctionnement avec lampes LED MR16	Works with MR16 LED lamps	<b>Funcionamento com lâmpadas LED MR16</b>	MR16 LED
Funcionamiento con lámparas LED PAR16	Fonctionnement avec lampes LED PAR16	Works with PAR16 LED lamps	<b>Funcionamento com lâmpadas LED PAR16</b>	PAR16 LED
Funcionamiento con lámparas LED AR111	Fonctionnement avec lampes LED AR111	Works with AR111 LED lamps	<b>Funcionamento com lâmpadas LED AR111</b>	111 LED
Funcionamiento con lámparas LED Estándar A60	Fonctionnement avec lampes LED Standard A60	Works with standard A60 LED lamps	<b>Standard A60 LED</b>	A60 LED
Funcionamiento con módulos LED	Fonctionnement avec modules LED	Works with LED modules	<b>Funcionamento com módulos LED</b>	ENGINE LED
Flujo luminoso (lm)	Flux lumineux (lm)	Luminous Flux (lm)	<b>Fluxo luminoso (lm)</b>	80Lm

Elementos Construtivos | Constructive Elements | Éléments constructifs | Elementos constructivos

	PT	EN	FR	ES
	<b>Difusor em vidro transparente</b>	Transparent glass diffuser	Diffuseur en verre transparent	Difusor de vidrio transparente
	<b>Difusor em vidro opalino</b>	Opal glass diffuser	Diffuseur en verre opalin	Difusor de vidrio opalino
	<b>Difusor em vidro fosco</b>	Frosted glass diffuser	Diffuseur en verre mat	Difusor de vidrio esmerilado
	<b>Difusor em vidro prismático</b>	Prismatic glass diffuser	Diffuseur en verre prismatique	Difusor de vidrio prismático
	<b>Difusor em acrílico transparente</b>	Transparent acrylic diffuser	Diffuseur en acrylique transparent	Difusor de acrílico transparente
	<b>Difusor em acrílico opalino</b>	Opal acrylic diffuser	Diffuseur en acrylique opalin	Difusor de acrílico opalino
	<b>Difusor em acrílico fosco</b>	Frosted acrylic diffuser	Diffuseur en acrylique mat	Difusor de acrílico mate
	<b>Difusor em acrílico prismático</b>	Prismatic acrylic diffuser	Diffuseur en acrylique prismatique	Difusor de acrílico prismático
	<b>Luminária sem difusor</b>	Luminaire without diffuser	Luminaire sans diffuseur	Luminaria sin difusor
	<b>ABS auto-extinguível</b>	Self-extinguishing ABS	ABS auto extinguable	ABS auto extinguable
	<b>Polycarbonato</b>	Polycarbonate	Polycarbonate	Polycarbonato
	<b>Alumínio extrudido</b>	Extruded aluminium	Aluminium extrudé	Aluminio extruido
	<b>Alumínio injetado</b>	Injected aluminium	Aluminium injecté	Aluminio inyectado
	<b>Aço inoxidável AISI 302</b>	AISI 302 stainless steel	Acier inoxydable AISI 302	Acero inoxidable AISI 302
	<b>Aço inoxidável AISI 304</b>	AISI 304 stainless steel	Acier inoxydable AISI 304	Acero inoxidable AISI 304
	<b>Aço inoxidável AISI 304</b>	AISI 304 stainless steel	Acier inoxydable AISI 304	Acero inoxidable AISI 304
	<b>Aço inoxidável AISI 316</b>	AISI 316 stainless steel	Acier inoxydable AISI 316	Acero inoxidable AISI 316
	<b>Aço inoxidável AISI 316</b>	AISI 316 stainless steel	Acier inoxydable AISI 316	Acero inoxidable AISI 316
	<b>Vidro</b>	Glass	Verre	Vidrio
	<b>Aço</b>	Steel	Acier	Acero
	<b>PMMA transparente</b>	Transparent PMMA	PMMA transparent	PMMA transparente
	<b>PMMA opalino</b>	Opal PMMA	PMMA opalin	PMMA opalino
	<b>PMMA fosco</b>	Frosted PMMA	PMMA mat	PMMA mate
	<b>Acabamento em branco</b>	White finish	Finition en blanc	Acabado en blanco
	<b>Acabamento em preto</b>	Black finish	Finition en noir	Acabado en negro
	<b>Acabamento em cinzento metálico</b>	Metallic grey finish	Finition en gris métallisé	Acabado en gris metálico
	<b>Acabamento em cinzento mate</b>	Matt grey finish	Finition en gris mat	Acabado en gris mate
	<b>Acabamento em cinzento pedra</b>	Stone grey finish	Finition en gris pierre	Acabado en gris piedra



Elementos Constructivos | Constructive Elements | Éléments constructifs | Elementos constructivos

ES	FR	EN	PT	
Acabado en acero cepillado	Finition en acier brossé	Brushed steel finish	<b>Acabamento em aço escovado</b>	
Acabado en acero inoxidable	Finition en acier inox	Stainless steel finish	<b>Acabamento aço inox</b>	
Acabado en aluminio cepillado	Finition en aluminium brossé	Brushed aluminium finish	<b>Acabamento em alumínio escovado</b>	
Acabado en aluminio pulido	Finition en aluminium poli	Polished aluminium finish	<b>Acabamento em alumínio polido</b>	
Acabado en antracita	Finition en anthracite	Anthracite finish	<b>Acabamento em antracite</b>	
Acabado en cromado	Finition en chromé	Chrome finish	<b>Acabamento em cromado</b>	
Acabado en dorado	Finition en doré	Gold finish	<b>Acabamento em dourado</b>	
Acabado en bronce	Finition en bronze	Bronze finish	<b>Acabamento em bronze</b>	
Acabado en cepillado	Finition en brossé	Brushed finish	<b>Acabamento em escovado</b>	
Azul	Bleu	Blue	<b>Azul</b>	
Verde	Vert	Green	<b>Verde</b>	
Amarillo	Jaune	Yellow	<b>Amarelo</b>	
Rojo	Rouge	Red	<b>Vermelho</b>	
Naranja	Orange	Orange	<b>Laranja</b>	
Violeta	Violet	Violet	<b>Violeta</b>	
Beige	Beige	Beige	<b>Bege</b>	
Índice de protección contra sólidos y líquidos (ver pág. 204)	Indice de protection contre les solides et les liquides (voir page 204)	IP rating against intrusion from solids and liquids (see page 204)	<b>Índice de proteção contra sólidos e líquidos (ver pág. 204)</b>	
Índice de resistencia mecánica al impacto (ver pág. 204)	Indice de résistance mécanique à l'impact (voir page 204)	Mechanical resistance against impact (see page 204)	<b>Índice de resistência mecânica ao impacto (ver pág. 204)</b>	



Informação adicional | Additional information | Informations complémentaires | Información adicional

PT	EN	FR	ES
 Permite rotação horizontal (indicação em graus °)	Possible horizontal rotation (in degrees °)	Permet la rotation horizontale (indication en degrés °)	Permite la rotación horizontal (indicación en grados)
 Permite orientação horizontal e vertical (movimento giroscópico)	Possible horizontal and vertical rotation (gyroscopic movement)	Permet l'orientation horizontale et verticale (mouvement gyroscopique)	Permite la orientación horizontal y vertical (movimiento giroscópico)
 Permite orientação vertical em apenas 1 sentido (indicação em graus °)	Vertical rotation in only one direction (in degrees °)	Permet l'orientation verticale dans 1 sens seulement (indication en degrés °)	Permite la orientación vertical en 1 sentido (indicación en grados)
 Permite orientação vertical em 2 sentidos (indicação em graus °)	Vertical rotation in two directions (in degrees °)	Permet l'orientation verticale dans 2 sens (indication en degrés °)	Permite la orientación vertical en 2 sentidos (indicación en grados)
 Luminária adequada para iluminação de espaços comerciais	Luminaire suitable for shop lighting	Luminaire approprié pour l'illumination d'espaces commerciaux	Luminaria adecuada para la iluminación de espacios comerciales
 Fornecido com cabo para suspensão (comprimento máx. mts)	Supplied with suspension cable (maximum length in metres)	Fourni avec un câble de suspension (longueur max. mts)	Se suministra con cable de suspensión (longitud máx. metros)
 Fornecido com cabo para suspensão (comprimento máx. mts)	Supplied with suspension cable (maximum length in metres)	Fourni avec un câble de suspension (longueur max. mts)	Se suministra con cable de suspensión (longitud máx. metros)
 Fornecido com cabo para suspensão (comprimento máx. mts)	Supplied with suspension cable (maximum length in metres)	Fourni avec un câble de suspension (longueur max. mts)	Se suministra con cable de suspensión (longitud máx. metros)
 Luminária dotada de dois buçins para efetuar repicagem	Luminaire with two cable glands for rerouting	Luminaire doté de deux presse-étoupes pour effectuer le repiquage	Luminaria dotada de dos prensaestopas para realizar derivación
 Admite uma carga máxima (indicação em kg)	Maximum load supported (in kg)	Permet une charge maximale (indication en kg)	Admite una carga máxima (indicación en kg)
 Admite uma carga máxima (indicação em kg)	Maximum load supported (in kg)	Permet une charge maximale (indication en kg)	Admite una carga máxima (indicación en kg)
 Indicação tempo de vida útil (indicação em horas)	Lifetime (in hours)	Indication du temps de vie utile (indication en heures)	Indicación de tiempo de vida útil (indicación en horas)
 Fácil instalação	Easy to install	Installation facile	Fácil instalación
 Substituir o difusor em caso de quebra	Replace broken diffuser	Remplacer le diffuseur en cas de cassure	Sustituir el difusor en caso de rotura
 Luminária fabricada de acordo com as normas de segurança elétrica e demais legislação aplicável	Luminaire manufactured in accordance with electrical safety standards and other applicable legislation	Luminaire fabriqué en accord avec les normes de sécurité électrique et autre législation applicable	Luminaria de techo fabricada de acuerdo con las normas de seguridad eléctrica y demás legislación aplicable
 Luminária totalmente flexível	Fully flexible luminaire	Luminaire totalement flexible	Luminaria totalmente flexible
 Elevada resistência ao impacto	High resistance against impact	Résistance élevée à l'impact	Alta resistencia al impacto
 Necessita de manutenção e limpeza periódica	Regular cleaning and maintenance required	Nécessite de manutention et de nettoyage périodique	Requiere mantenimiento y limpieza periódica
 Necessita fundo de drenagem para escoamento de águas	Floor drainage of liquids required	Nécessite d'un fond de drainage pour écoulement des eaux	Necesita fondo de drenaje para la evacuación de agua
 Luminária fornecida com cabo de alimentação (indicação do tipo e metros)	Luminaire supplied with electrical cable (type and length in metres)	Luminaire fourni avec un câble d'alimentation (indication du type et des mètres)	Luminaria suministrada con cable de alimentación (indicación del tipo y metros)
 Luminária fornecida com cabo de alimentação e ficha macho	Luminaire supplied with cable and connection plug	Luminaire fourni avec un câble d'alimentation et d'une fiche mâle	Luminaria suministrada con cable de alimentación y enchufe macho
 Suporte de lâmpada não incluído na luminária	Lamp holder not included in luminaire	Support de lampe non inclus dans le luminaire	Soporte de bombilla no incluído en la luminaria
 Suporte de lâmpada incluído na luminária	Lamp holder included in luminaire	Support de lampe inclus dans le luminaire	Soporte de bombilla incluído en la luminaria
 Novo produto	New product	Nouveau produit	Nuevo producto
 Cumpre a diretiva REEE	Complies with REEE directive	Respecte la directive REEE	Cumple con la directiva RAEE
 Cumpre a diretiva ROHS	Complies with ROHS directive	Respecte la directive ROHS	Cumple con la directiva ROHS
 Ostenta certificação TUV GS	TUV GS Certified	Porte la certification TUV GS	Con certificación TUV GS
 Ostenta certificação TUV	TUV Certified	Porte la certification TUV	Con certificación TUV

Informação adicional | Additional information | Informations complémentaires | Información adicional

ES	FR	EN	PT	
Garantía de 4 años en toda la gama Flexistrip	Garantie 4 ans pour toute la gamme Flexistrip	4-year warranty for entire Flexistrip range	<b>Garantia 4 anos em toda a gama Flexistrip</b>	
Luminaria con garantía Lumitek	Luminaire avec la garantie Lumitek	Luminaire with Lumitek warranty	<b>Luminária com garantia Lumitek</b>	
Calidad comprobada en el producto	Qualité prouvée pour le produit	Proven product quality	<b>Qualidade comprovada no produto</b>	
Diseño patentado	Conception brevetée	Patented design	<b>Design patenteado</b>	
Marca registrada UE	Marque enregistrée UE	EU registered trademark	<b>Marca registada UE</b>	
Estilo vintage	Style Vintage	Vintage style	<b>Estilo vintage</b>	
Sustitución rápida y sencilla del módulo LED	Substitution rapide et simple du module LED	Quick and easy to replace LED	<b>Substituição rápida e simples do módulo LED</b>	
Luminaria con efecto decorativo	Luminaire avec effet décoratif	Luminaire with decorative effect	<b>Luminária com efeito decorativo</b>	
Luminaria con efecto decorativo	Luminaire avec effet décoratif	Luminaire with decorative effect	<b>Luminária com efeito decorativo</b>	
Permite el funcionamiento a temperatura ambiente entre [ - ... y + ... ]	Permet le fonctionnement pour des températures ambiantes de [ - ... et + ... ]	Works in ambient temperatures between [ - ... and + ... ]	<b>Permite o funcionamento em temperaturas ambientes de [ - ... e + ... ]</b>	
Radio de curvatura mínimo admisible	Rayon de courbure minimal admissible	Minimum radius of curvature admissible	<b>Raio de curvatura mínimo admissível</b>	
Consumo en amperios (A) por metro de cinta	Consommation en ampères (A) par mètre de ruban	Consumption in amperes (A) per metre of strip	<b>Consumo em amperes (A) por metro de fita</b>	
Indicación del espesor de cobre de la cinta (medido en OZ)	Indication de l'épaisseur de cuivre du ruban (mesuré en OZ)	Strip's copper thickness (in OZ)	<b>Indicação da espessura de cobre da fita (medido em OZ)</b>	
Espaciado existente entre LED	Espacement existant entre LEDs	Spacing between LEDs	<b>Espaçamento existente entre LEDs</b>	
Distancia entre cortes y número de LED existentes	Distance entre coupures et nombre de LEDs existantes	Spacing between cuts and number of LEDs	<b>Distância entre cortes e número de LEDs existentes</b>	
Adhesivo térmico de marca 3M	Adhésif thermique de la marque 3M	3M thermal adhesive tape	<b>Adesivo térmico da marca 3M</b>	
Revestimiento de silicona	Revêtement en silicone	Silicone coating	<b>Revestimento em silicone</b>	



Marcação CE:

A ostentação da marcação CE, indica que o equipamento está em conformidade com as directivas europeias para material eléctrico de certos limites de tensão 2006/95/CE e compatibilidade electromagnética 2004/108/CE.

CE Marking:

A CE Marking means that the equipment is in compliance with the European Directives for electrical material of certain voltage limits 2006/95/CE and electromagnetic compatibility 2004/108/CE.

Marca CE:

La marca CE, indica que el equipo está en conformidad con las directivas europeas para material eléctrico dentro de determinados límites de tensión 2006/95/CE y compatibilidad electromagnética 2004/108/CE.

Marquage CE

La présentation du marquage CE indique que le matériel est conforme avec les directives européennes pour les appareils électriques de certaines limites de tension 2006/95/CE et de comptabilité électromagnétique 2004/108/CE.